

# BRCS1C0P06DPQ

Rev.A Apr.-2025

## 描述 / Descriptions

TO-252 塑封封装 P 沟道场效应管。

P-CHANNEL MOSFET in a TO-252 Plastic Package.

## 特征 / Features

$V_{DS} (V) = -60V$   $I_D = -14 A (V_{GS} = \pm 20V)$

$R_{DS(on)1} @ -10V \leq 100m\Omega$  (Type.  $83m\Omega$ )

$R_{DS(on)2} @ -4.5V \leq 130m\Omega$  (Type.  $100m\Omega$ )

符合 AEC-Q101 标准高可靠性要求，无卤产品。

Qualified to AEC-Q101 Standards for High Reliability, HF Product.

## 用途 / Applications

电机驱动、电动工具、LED 照明，满足汽车应用的严格要求。

Motor Drive, Power Tools, LED Lighting, Meet the stringent requirements of automotive applications.

## 内部等效电路 / Equivalent Circuit

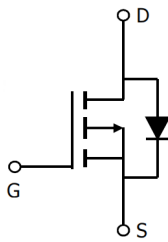

## 引脚排列 / Pinning

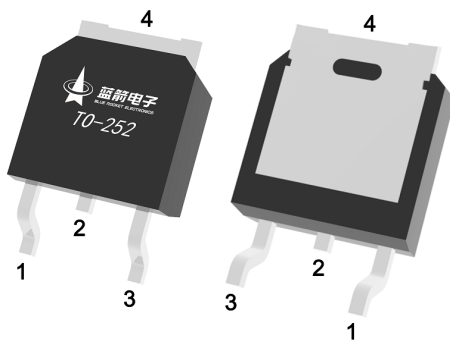

PIN 1 : G

PIN 2 : D

PIN 3 : S

PIN 4 : D

## 印章代码 / Marking

见印章说明。

See Marking Instructions.

**极限参数 / Absolute Maximum Ratings(Ta=25°C)**

参数 Parameter	符号 Symbol	数值 Rating	单位 Unit
Drain-Source Voltage	V <sub>DSS</sub>	-60	V
Drain Current	I <sub>D</sub> (Tc=25°C)	-14	A
Drain Current - Pulsed	I <sub>DM</sub>	-42.5	A
Gate-Source Voltage	V <sub>GS</sub>	±20	V
Power Dissipation	P <sub>D</sub> (Tc=25°C)	32	W
Storage Temperature Range	T <sub>stg</sub>	-55~150	°C
Thermal Resistance-Junction to Ambient	t ≤ 10s	28	°C/W
	Steady-State	55	
Thermal Resistance-Junction to Case	Steady-State	3.91	

**电性能参数 / Electrical Characteristics(Ta=25°C)**

参数 Parameter	符号 Symbol	测试条件 Test Conditions	最小值 Min	典型值 Typ	最大值 Max	单位 Unit
Drain-Source Breakdown Voltage	V <sub>(BR)DSS</sub>	V <sub>GS</sub> =0V I <sub>D</sub> =-250μA	-60	-65		V
Gate Threshold Voltage	V <sub>GS(th)</sub>	V <sub>DS</sub> =V <sub>GS</sub> I <sub>D</sub> =-250μA	-1	-1.6	-2.5	V
Static Drain-Source On-Resistance	R <sub>DS(on)</sub>	V <sub>GS</sub> =-10V I <sub>D</sub> =-10A		83	100	mΩ
		V <sub>GS</sub> =-4.5V I <sub>D</sub> =-5A		100	130	mΩ
Zero Gate Voltage Drain Current	I <sub>DSS</sub>	V <sub>DS</sub> =-60V V <sub>GS</sub> =0V			-1.0	μA
Gate-Body leakage current	I <sub>GSS</sub>	V <sub>GS</sub> =±20V V <sub>DS</sub> =0V			±100	nA
Drain-Source Diode Forward Voltage	V <sub>SD</sub>	V <sub>GS</sub> =0V I <sub>S</sub> =-1A T <sub>J</sub> =25°C			-1.2	V
Gate resistance	R <sub>g</sub>	f=1MHz		6.5		Ω
Input Capacitance	C <sub>iss</sub>	V <sub>DS</sub> =-25V V <sub>GS</sub> =0V f=1.0MHz		890		pF
Output Capacitance	C <sub>oss</sub>			90		
Reverse Transfer Capacitance	C <sub>rss</sub>			64		
Total Gate Charge	Q <sub>g(-10V)</sub>	V <sub>DS</sub> =-10V V <sub>GS</sub> =-10.0V I <sub>D</sub> =-3A		12.3		nC
Total Gate Charge	Q <sub>g(-4.5V)</sub>			6.3		
Gate-to-Source Charge	Q <sub>gs</sub>			1.6		
Gate-to-Drain Charge	Q <sub>gd</sub>			2.4		
Turn-On Delay Time	t <sub>d(on)</sub>	V <sub>DS</sub> =-10V V <sub>GS</sub> =-10V R <sub>L</sub> =5.4Ω R <sub>GEN</sub> =3Ω		12		ns
Turn-On Rise Time	t <sub>r</sub>			20		
Turn-Off Delay Time	t <sub>d(off)</sub>			20		
Turn-Off Fall Time	t <sub>f</sub>			25		

电参数曲线图 / Electrical Characteristic Curve

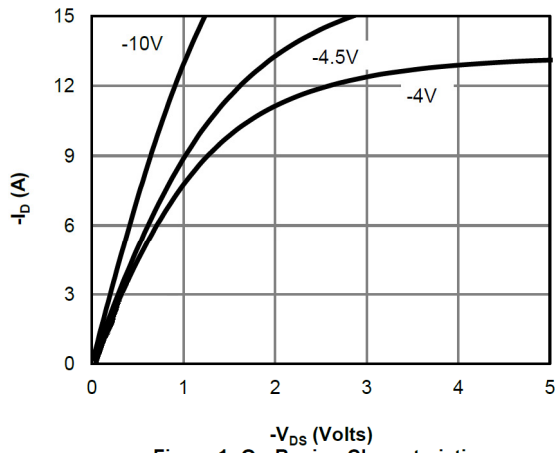

Figure 1: On-Region Characteristics

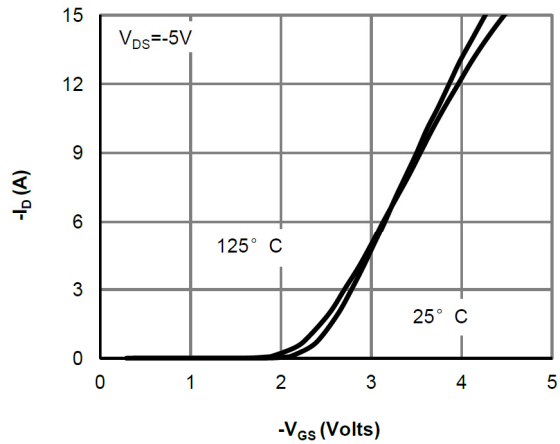

Figure 2: Transfer Characteristics

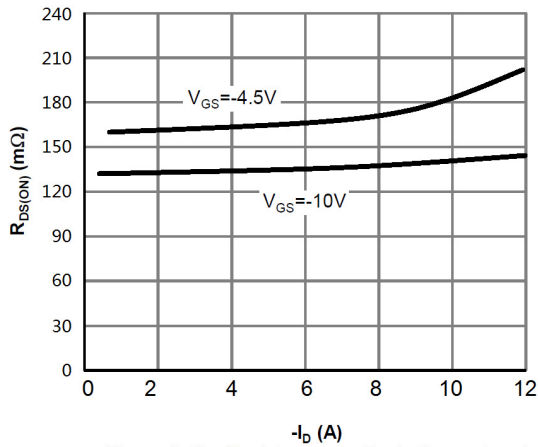

Figure 3: On-Resistance vs. Drain Current and Gate Voltage

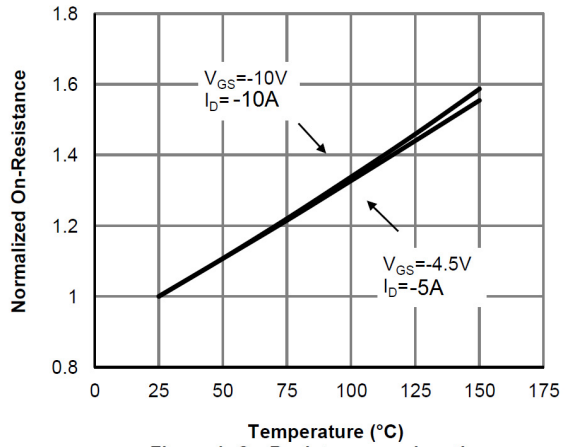

Figure 4: On-Resistance vs. Junction Temperature

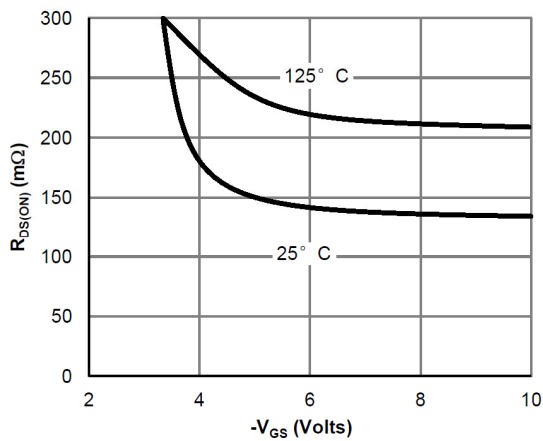

Figure 5: On-Resistance vs. Gate-Source Voltage

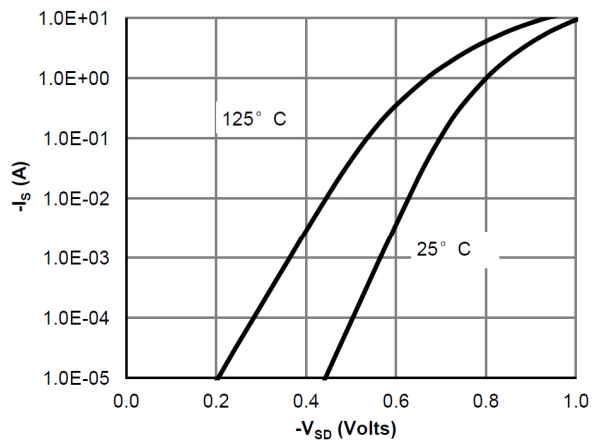

Figure 6: Body-Diode Characteristics

**电参数曲线图 / Electrical Characteristic Curve**

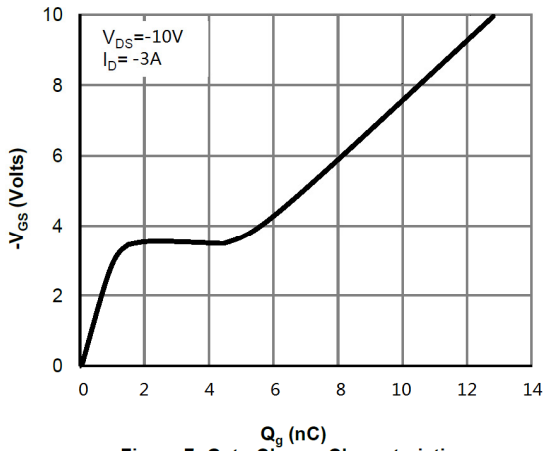

Figure 7: Gate-Charge Characteristics

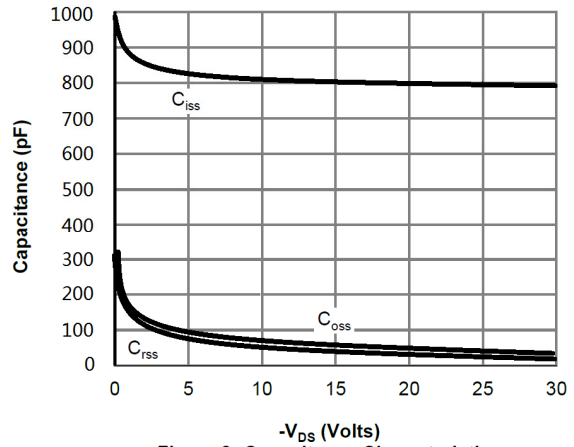

Figure 8: Capacitance Characteristics

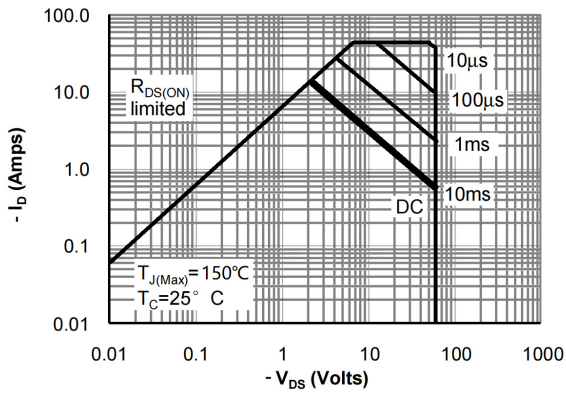

Figure 9: Maximum Forward Biased Safe Operating Area

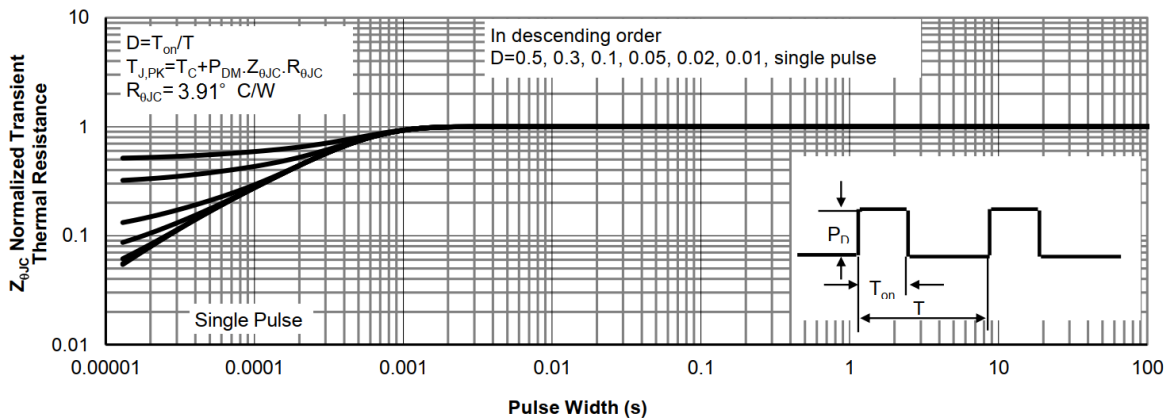
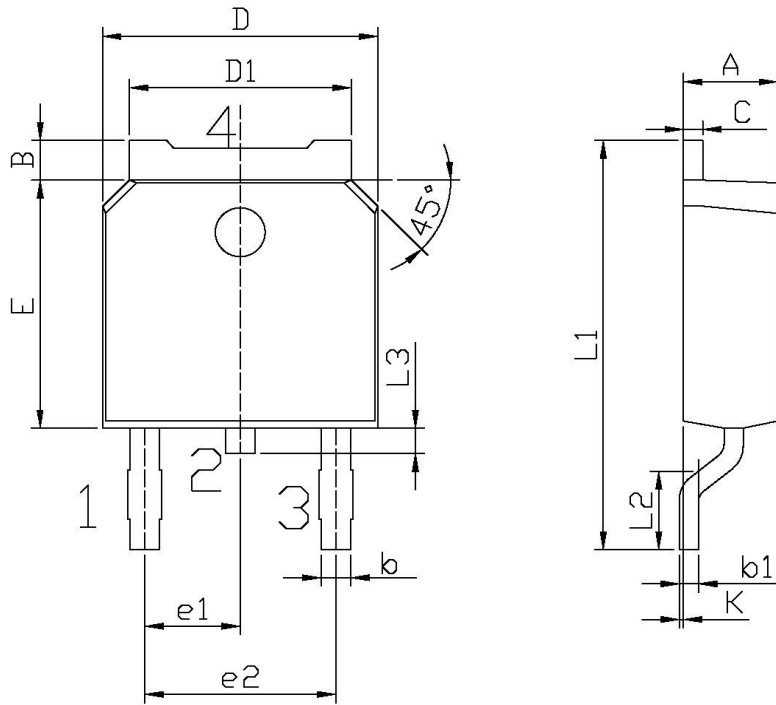

Figure 10: Normalized Maximum Transient Thermal Impedance

**外形尺寸图 / Package Dimensions**



单位: mm

Symbol	Dimensions In Millimeters		Symbol	Dimensions In Millimeters	
	Min	Max		Min	Max
A	2.20	2.40	E	5.95	6.25
B	0.95	1.25	e1	2.24	2.34
b	0.70	0.90	e2	4.43	4.73
b1	0.45	0.55	L1	9.85	10.35
C	0.45	0.55	L2	1.70	2.00
D	6.45	6.75	L3	0.60	0.90
D1	5.10	5.50	K	0.00	0.10

TO-252

## 印章说明 / Marking Instructions

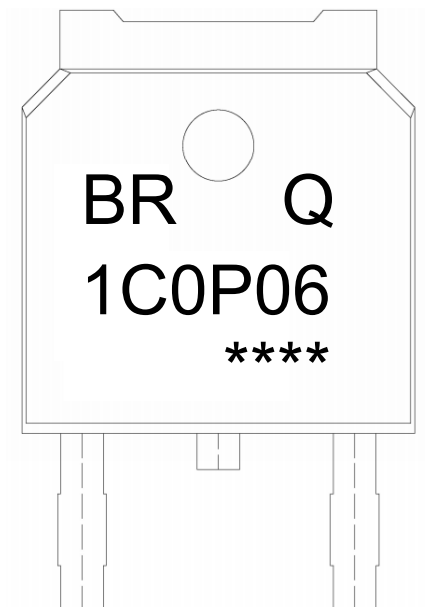

说明：

BR： 为公司代码

Q： 为汽车无卤产品标识

1C0P06： 为型号代码

\*\*\*\*： 为生产批号代码，随生产批号变化

Note:

BR: Company Code

Q: Automobile halogen-free product Code

1C0P06: Product Type Code

\*\*\*\*: Lot No. Code, code change with Lot No

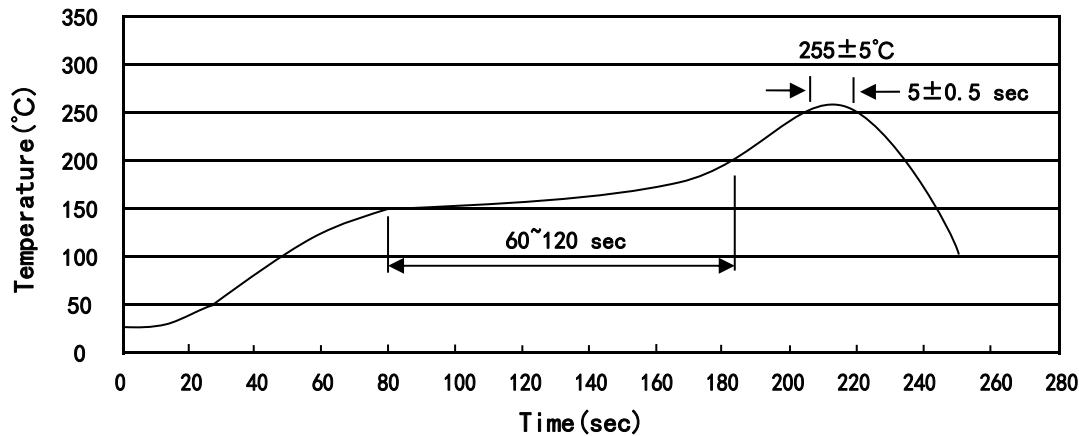
**回流焊温度曲线图(无铅) / Temperature Profile for IR Reflow Soldering(Pb-Free)**

说明：

- 1、预热温度 150~200°C，时间 60~120sec;
- 2、峰值温度 255±5°C，时间持续为 5±0.5sec;
- 3、焊接制程冷却速度为 2~10°C/sec.

Note:

- 1.Preheating:150~200°C, Time:60~120sec.
- 2.Peak Temp.:255±5°C, Duration:5±0.5sec.
3. Cooling Speed: 2~10°C/sec.

**耐焊接热试验条件 / Resistance to Soldering Heat Test Conditions**

温度：260±5°C

时间：10±1 sec.

Temp.:260±5°C

Time:10±1 sec

**包装规格 / Packaging SPEC.**

卷盘包装 / REEL

Package Type 封装形式	Units 包装数量					Dimension 包装尺寸 (unit: mm <sup>3</sup> )		
	Units/Reel 只/卷盘	Reels/Inner Box 卷盘/盒	Units/Inner Box 只/盒	Inner Boxes/Outer Box 盒/箱	Units/Outer Box 只/箱	Reel	Inner Box 盒	Outer Box 箱
TO-252	2,500	2	5,000	6	30,000	13" ×16	360×360×50	380×335×366

套管包装 / TUBE

Package Type 封装形式	Units 包装数量					Dimension 包装尺寸 (unit: mm <sup>3</sup> )		
	Units/Tube 只/套管	Tubes/Inner Box 套管/盒	Units/Inner Box 只/盒	Inner Boxes/Outer Box 盒/箱	Units/Outer Box 只/箱	Tube 套管	Inner Box 盒	Outer Box 箱
TO-251/252	75	48	3,600	5	18,000	526×20.5×5.25	555×164×50	575×290×180

**使用说明 / Notices**